



3 Series Mixed Domain Oscilloscope MDO32 and MDO34 Quick Start Manual

Warning: The servicing instructions are for use by qualified personnel only. To avoid personal injury, do not perform any servicing unless you are qualified to do so. Refer to all safety summaries prior to performing service.

Supports product Firmware V1.1 and above

Register now!
Click the following link to protect your product.
www.tek.com/register



077-1797-00

Copyright © Tektronix. All rights reserved. Licensed software products are owned by Tektronix or its subsidiaries or suppliers, and are protected by national copyright laws and international treaty provisions. Tektronix products are covered by U.S. and foreign patents, issued and pending. Information in this publication supersedes that in all previously published material. Specifications and price change privileges reserved.

TEKTRONIX and TEK are registered trademarks of Tektronix, Inc.

Contacting Tektronix

Tektronix, Inc.

14150 SW Karl Braun Drive

P.O. Box 500

Beaverton, OR 97077

USA

For product information, sales, service, and technical support:

- In North America, call 1-800-833-9200.
- Worldwide, visit to www.tek.com find contacts in your area.

Table of Contents

Important safety information.....	4
General safety summary.....	4
Service safety summary.....	6
Terms in this manual.....	7
Terms on the product.....	7
Symbols on the product.....	7
Compliance information.....	8
Safety compliance.....	8
Environmental compliance.....	9
Getting started.....	10
Key features.....	10
Documentation.....	10
Check shipped accessories.....	11
Safely rotate the handle.....	11
Operating requirements.....	12
Input signal requirements.....	13
Lock the oscilloscope.....	14
Powering the instrument.....	14
Check that the oscilloscope passes power-on self tests.....	15
Connecting probes.....	15
Rackmount information.....	16
Remote access from a Web browser.....	16
Connect the oscilloscope to a PC using a USB cable.....	17
Cleaning.....	17
Getting acquainted with your instrument.....	18
Front panel controls and connectors.....	18
Rear panel connections.....	19
User interface	20
Identifying items in the time domain display.....	21
Identifying items in the frequency domain display.....	23
Badges.....	25
Configuration menus.....	29
Zoom user interface	31
Using the touchscreen interface for common tasks.....	32
Configure the instrument.....	33
Set the date and time.....	33
Download and install the latest firmware.....	33
Run Signal Path Compensation (SPC).....	34
Compensate TPP0250, TPP0500B, or TPP1000 probes.....	34
Connect to a network (LAN).....	36
Index.....	37

Important safety information

This manual contains information and warnings that must be followed by the user for safe operation and to keep the product in a safe condition.

To safely perform service on this product, see the *Service safety summary* that follows the *General safety summary*.

General safety summary

Use the product only as specified. Review the following safety precautions to avoid injury and prevent damage to this product or any products connected to it. Carefully read all instructions. Retain these instructions for future reference.

This product shall be used in accordance with local and national codes.

For correct and safe operation of the product, it is essential that you follow generally accepted safety procedures in addition to the safety precautions specified in this manual.

The product is designed to be used by trained personnel only.

Only qualified personnel who are aware of the hazards involved should remove the cover for repair, maintenance, or adjustment.

Before use, always check the product with a known source to be sure it is operating correctly.

This product is not intended for detection of hazardous voltages.

Use personal protective equipment to prevent shock and arc blast injury where hazardous live conductors are exposed.

While using this product, you may need to access other parts of a larger system. Read the safety sections of the other component manuals for warnings and cautions related to operating the system.

When incorporating this equipment into a system, the safety of that system is the responsibility of the assembler of the system.

To avoid fire or personal injury

Use proper power cord.

Use only the power cord specified for this product and certified for the country of use. Do not use the provided power cord for other products.

Ground the product.

This product is grounded through the grounding conductor of the power cord. To avoid electric shock, the grounding conductor must be connected to earth ground. Before making connections to the input or output terminals of the product, ensure that the product is properly grounded. Do not disable the power cord grounding connection.

Power disconnect.

The power cord disconnects the product from the power source. See instructions for the location. Do not position the equipment so that it is difficult to operate the power cord; it must remain accessible to the user at all times to allow for quick disconnection if needed.

Connect and disconnect properly.

Do not connect or disconnect probes or test leads while they are connected to a voltage source.

Use only insulated voltage probes, test leads, and adapters supplied with the product, or indicated by Tektronix to be suitable for the product.

Observe all terminal ratings.

To avoid fire or shock hazard, observe all rating and markings on the product. Consult the product manual for further ratings information before making connections to the product.

Do not exceed the Measurement Category (CAT) rating and voltage or current rating of the lowest rated individual component of a product, probe, or accessory. Use caution when using 1:1 test leads because the probe tip voltage is directly transmitted to the product.

Do not apply a potential to any terminal, including the common terminal, that exceeds the maximum rating of that terminal.

Do not float the common terminal above the rated voltage for that terminal.

Do not operate without covers

Do not operate this product with covers or panels removed, or with the case open. Hazardous voltage exposure is possible.

Avoid exposed circuitry

Do not touch exposed connections and components when power is present.

Do not operate with suspected failures.

If you suspect that there is damage to this product, have it inspected by qualified service personnel.

Disable the product if it is damaged. Do not use the product if it is damaged or operates incorrectly. If in doubt about safety of the product, turn it off and disconnect the power cord. Clearly mark the product to prevent its further operation.

Before use, inspect voltage probes, test leads, and accessories for mechanical damage and replace when damaged. Do not use probes or test leads if they are damaged, if there is exposed metal, or if a wear indicator shows.

Examine the exterior of the product before you use it. Look for cracks or missing pieces.

Use only specified replacement parts.

Do not operate in wet/damp conditions

Be aware that condensation may occur if a unit is moved from a cold to a warm environment.

Do not operate in an explosive atmosphere

Keep product surfaces clean and dry

Remove the input signals before you clean the product.

Provide proper ventilation.

Refer to the installation instructions in the manual for details on installing the product so it has proper ventilation.

Slots and openings are provided for ventilation and should never be covered or otherwise obstructed. Do not push objects into any of the openings.

Provide a safe working environment

Always place the product in a location convenient for viewing the display and indicators.

Avoid improper or prolonged use of keyboards, pointers, and button pads. Improper or prolonged keyboard or pointer use may result in serious injury.

Be sure your work area meets applicable ergonomic standards. Consult with an ergonomics professional to avoid stress injuries.

Use care when lifting and carrying the product. This product is provided with a handle or handles for lifting and carrying.

Use only the Tektronix rackmount hardware specified for this product.

Probes and test leads

Before connecting probes or test leads, connect the power cord from the power connector to a properly grounded power outlet.

Keep fingers behind the protective barrier, protective finger guard, or tactile indicator on the probes. Remove all probes, test leads and accessories that are not in use.

Use only correct Measurement Category (CAT), voltage, temperature, altitude, and amperage rated probes, test leads, and adapters for any measurement.

Beware of high voltages

Understand the voltage ratings for the probe you are using and do not exceed those ratings. Two ratings are important to know and understand:

- The maximum measurement voltage from the probe tip to the probe reference lead.
- The maximum floating voltage from the probe reference lead to earth ground.

These two voltage ratings depend on the probe and your application. Refer to the Specifications section of the manual for more information.



WARNING: To prevent electrical shock, do not exceed the maximum measurement or maximum floating voltage for the oscilloscope input BNC connector, probe tip, or probe reference lead.

Connect and disconnect properly.

Connect the probe output to the measurement product before connecting the probe to the circuit under test. Connect the probe reference lead to the circuit under test before connecting the probe input. Disconnect the probe input and the probe reference lead from the circuit under test before disconnecting the probe from the measurement product.

De-energize the circuit under test before connecting or disconnecting the current probe.

Connect the probe reference lead to earth ground only.

Do not connect a current probe to any wire that carries voltages or frequencies above the current probe voltage rating.

Inspect the probe and accessories

Before each use, inspect probe and accessories for damage (cuts, tears, or defects in the probe body, accessories, or cable jacket). Do not use if damaged.

Ground-referenced oscilloscope use

Do not float the reference lead of this probe when using with ground-referenced oscilloscopes. The reference lead must be connected to earth potential (0 V).

Service safety summary

The *Service safety summary* section contains additional information required to safely perform service on the product. Only qualified personnel should perform service procedures. Read this *Service safety summary* and the *General safety summary* before performing any service procedures.

To avoid electric shock

Do not touch exposed connections.

Do not service alone

Do not perform internal service or adjustments of this product unless another person capable of rendering first aid and resuscitation is present.

Disconnect power

To avoid electric shock, switch off the product power and disconnect the power cord from the mains power before removing any covers or panels, or opening the case for servicing.

Use care when servicing with power on

Dangerous voltages or currents may exist in this product. Disconnect power, remove battery (if applicable), and disconnect test leads before removing protective panels, soldering, or replacing components.

Verify safety after repair

Always recheck ground continuity and mains dielectric strength after performing a repair.

Terms in this manual

These terms may appear in this manual:



WARNING: Warning statements identify conditions or practices that could result in injury or loss of life.



CAUTION: Caution statements identify conditions or practices that could result in damage to this product or other property.

Terms on the product

These terms may appear on the product:

- DANGER indicates an injury hazard immediately accessible as you read the marking.
- WARNING indicates an injury hazard not immediately accessible as you read the marking.
- CAUTION indicates a hazard to property including the product.

Symbols on the product



When this symbol is marked on the product, be sure to consult the manual to find out the nature of the potential hazards and any actions which have to be taken to avoid them. (This symbol may also be used to refer the user to ratings in the manual.)

The following symbols(s) may appear on the product.



CAUTION
Refer to Manual



Protective Ground
(Earth) Terminal



Functional
Earth Terminal



Chassis Ground



Standby

Compliance information

This section lists the safety and environmental standards with which the instrument complies. This product is intended for use by professionals and trained personnel only; it is not designed for use in households or by children.

Questions about compliance information may be directed to the following address:

Tektronix, Inc.

PO Box 500, MS 19-045

Beaverton, OR 97077, USA

tek.com

Safety compliance

This section lists other safety compliance information.

Equipment type

Test and measuring equipment.

Safety class

Class 1 – grounded product.

Pollution degree description

A measure of the contaminants that could occur in the environment around and within a product. Typically the internal environment inside a product is considered to be the same as the external. Products should be used only in the environment for which they are rated.

- Pollution Degree 1. No pollution or only dry, nonconductive pollution occurs. Products in this category are generally encapsulated, hermetically sealed, or located in clean rooms.
- Pollution Degree 2. Normally only dry, nonconductive pollution occurs. Occasionally a temporary conductivity that is caused by condensation must be expected. This location is a typical office/home environment. Temporary condensation occurs only when the product is out of service.
- Pollution Degree 3. Conductive pollution, or dry, nonconductive pollution that becomes conductive due to condensation. These are sheltered locations where neither temperature nor humidity is controlled. The area is protected from direct sunshine, rain, or direct wind.
- Pollution Degree 4. Pollution that generates persistent conductivity through conductive dust, rain, or snow. Typical outdoor locations.

Pollution degree rating

Pollution Degree 2 (as defined in IEC 61010-1). Note: Rated for indoor, dry location use only.

IP rating

IP20 (as defined in IEC 60529).

Measurement and overvoltage category descriptions

Measurement terminals on this product may be rated for measuring mains voltages from one or more of the following categories (see specific ratings marked on the product and in the manual).

- Measurement Category II. For measurements performed on circuits directly connected to the low-voltage installation.
- Measurement Category III. For measurements performed in the building installation.
- Measurement Category IV. For measurements performed at the source of low-voltage installation.



Note: Only mains power supply circuits have an overvoltage category rating. Only measurement circuits have a measurement category rating. Other circuits within the product do not have either rating.

Mains overvoltage category rating

Overvoltage Category II (as defined in IEC 61010-1)

Environmental compliance

This section provides information about the environmental impact of the product.

Product end-of-life handling

Observe the following guidelines when recycling an instrument or component:

Equipment recycling

Production of this equipment required the extraction and use of natural resources. The equipment may contain substances that could be harmful to the environment or human health if improperly handled at the product's end of life. To avoid release of such substances into the environment and to reduce the use of natural resources, we encourage you to recycle this product in an appropriate system that will ensure that most of the materials are reused or recycled appropriately.



This symbol indicates that this product complies with the applicable European Union requirements according to Directives 2012/19/EU and 2006/66/EC on waste electrical and electronic equipment (WEEE) and batteries. For information about recycling options, check the Tektronix Web site (www.tek.com/productrecycling).

Battery recycling

This product contains a small installed lithium metal button cell. Please properly dispose of or recycle the cell at its end of life according to local government regulations.

Perchlorate materials

This product contains one or more type CR lithium batteries. According to the state of California, CR lithium batteries are classified as perchlorate materials and require special handling. See www.dtsc.ca.gov/hazardouswaste/perchlorate for additional information.

Transporting batteries

The small lithium primary button cell contained in this equipment does not exceed 1 gram of lithium metal content per cell.

The cell type has been shown by the manufacturer to comply with the applicable requirements of the UN Manual of Tests and Criteria Part III, Sub-section 38.3. Consult your carrier to determine which lithium battery transportation requirements are applicable to your configuration, including to its re-packaging and re-labeling, prior to reshipment of the product by any mode of transport.

Getting started

This manual provides product safety and compliance information, describes how to connect and power on the oscilloscope, and introduces the basic instrument features, controls, and operations. See the product Help file for more detailed information. Go to tek.com/warranty-status-search for warranty information.

Key features

Welcome to the 3 Series MDO. The 3 Series MDO Oscilloscopes (MDO32 and MDO34) are 2- and 4-channel oscilloscopes, enabling you to efficiently and cost-effectively perform mixed domain debugging.

- A dedicated RF input channel for frequency domain measurements
- 1 GHz spectrum analyzer standard, 3 GHz optional
- Bandwidths from 100 MHz to 1 GHz
- 2- and 4-channels for time domain measurements
- Sixteen-channel digital input option
- Large 11.6" HD (1920 x 1080 pixel) capacitive touchscreen display
- User interface optimized for touchscreen use
- Sample rates of 2.5 GS/s on all analog channels (5 GS/s on 1 or 2 channels for the MDO34 or MDO32 with the 1 GHz option)
- 10 M points record length on all channels
- Maximum waveform capture rate: 280,000 waveforms/second, with FastAcq: >50,000 waveforms/second with normal operation
- Advanced triggering and analysis: I2C, SPI, USB 2.0, CAN, CAN FD, LIN, FlexRay, RS-232, RS-422, RS-485, UART, I2S, Left Justified (LJ), Right Justified (RJ), TDM, MIL-STD-1553, ARINC429 (with the appropriate option), and Parallel
- Power analysis (optional)
- Arbitrary function generator and 16 digital channels (optional)
- Digital voltmeter and trigger frequency counter free with product registration

Documentation

Review the following user documents before installing and using your instrument. These documents provide important operating information.

Product documentation

The following table lists the primary product specific documentation available for your product. These and other user documents are available for download from www.tek.com. Other information, such as demonstration guides, technical briefs, and application notes, can also be found at www.tek.com.

Document	Content
Help	In-depth operating information for the product. Available from the Help button in the product UI and as a downloadable PDF on www.tek.com/downloads .
Quick Start User Manual	Introduction to product hardware and software, installation instructions, turn on, and basic operating information.
Specifications and Performance Verification Technical Reference	Instrument specifications and performance verification instructions for testing instrument performance.
Programmer Manual	Commands for remotely controlling the instrument.

Table continued...

Document	Content
Declassification and Security Instructions	Information about the location of memory in the instrument. Instructions for declassifying and sanitizing the instrument.
Service Manual	Replaceable parts list, theory of operations, and repair and replace procedures for servicing an instrument.
Upgrade Instructions	Product upgrade installation information.
Rackmount Kit Instructions	Installation information for assembling and mounting an instrument using a specific rackmount.

How to find your product documentation

1. Go to www.tek.com.
2. Click **Download** in the green sidebar on the right side of the screen.
3. Select **Manuals** as the Download Type, enter your product model, and click **Search**.
4. View and download your product manuals. You can also click the Product Support Center and Learning Center links on the page for more documentation.

Check shipped accessories

Make sure that you received everything you ordered. If anything is missing, contact Tektronix Customer Support. In North America, call 1-800-833-9200. Worldwide, visit www.tek.com to find contacts in your area.

Check the packing list that came with your instrument to verify that you have received all standard accessories and ordered items. If you purchased factory options, tap **Help > About** to confirm that the option(s) are listed in the **Installed Options** table.

Standard accessories

Item	Quantity	Tektronix part number
Passive Voltage Probe, depends on instrument bandwidth	1 GHz bandwidth	One per analog channel
	350 MHz and 500 MHz	
	100 MHz and 200 MHz bandwidth	
Accessory bag	1	016-2144-xx
Power cord	1	Depends on region
Calibration certificate	1	N/A
OpenChoice® Desktop Software. Available for download from www.tek.com/software/downloads		

Safely rotate the handle

Use the correct process to eliminate the chance of pinching your thumb or rear-panel-connected cables while rotating the handle.



WARNING: Hold the top of the handle to rotate the handle on the instrument. Do not hold the handle from the sides and rotate, as this can pinch the base of your thumb between the handle and the case.



CAUTION: If you have routed any cables between the handle and the case, be careful when rotating the handle so that you do not pinch the cables.

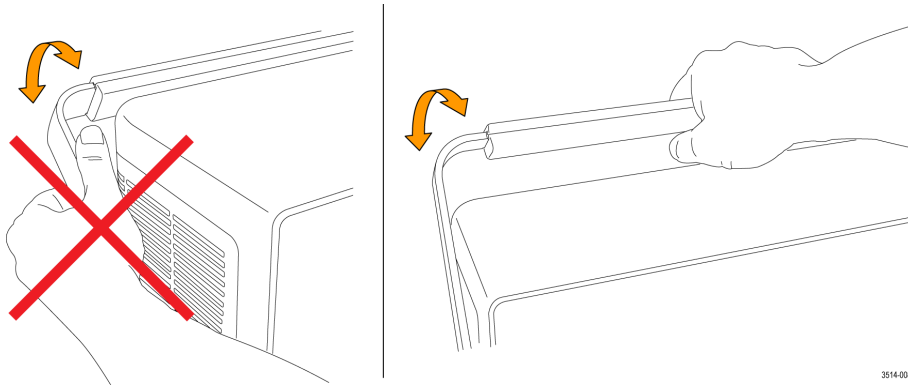

Operating requirements

Use the oscilloscope within the required operating temperature, power, altitude, and signal input voltage ranges to provide the most accurate measurements and safe instrument operation.

Environment requirements

Characteristic	Description
Operating temperature	-10 °C to +55 °C (+14 °F to +131 °F) For proper cooling, keep the sides and rear of the instrument clear of obstructions for 2 inches (51 mm).
Operating humidity	5% to 90% relative humidity (% RH) up to +40 °C (+104 °F), Noncondensing. 5% to 60% RH above +40 °C up to +55 °C (+104 °F to +131 °F), Noncondensing.
Operating altitude	Up to 3000 meters (9842 feet)

Power requirements

Characteristic	Description
Power source voltage	100 V - 240 V _{AC RMS} , ±10%, single phase
Power source frequency	50/60 Hz, 100-240 V 400 Hz ±10% at 100 to 132 V
Power consumption	130 W maximum

Input signal requirements

Keep the input signals within allowed limits to ensure the most accurate measurements and prevent damage to the analog and digital probes or instrument. Make sure that input signals are within the following requirements.

Table 1: Maximum analog input

Input	Description
Analog input channels, 1 M Ω setting, maximum input voltage at BNC	300 V _{RMS} Measurement Category II De-rate at 20 dB/decade between 4.5 MHz and 45 MHz, De-rate 14 db between 45 MHz and 450 MHz. Above 450 MHz, 5 V _{RMS} .
Analog input channels, 50 Ω setting, maximum input voltage at BNC	5 V _{RMS} with a peak at ± 20 V. (DF \leq 6.25%).
RF input maximum input voltage	Average Continuous Power: +20 dBm (0.1 W) DC maximum before damage: ± 40 VDC Max no damage +33 dBm (2 W) CW Peak Pulse Power: +45 dBm (32 W) Peak Pulse Power defined as <10 μ s pulse width, <1% duty cycle, and reference level of \geq +10 dBm

Table 2: Maximum input with a P6316 Digital Probe

Input	Description
Threshold Accuracy	$\pm(100 \text{ mV} + 3\% \text{ of threshold setting after calibration})$
Threshold Range	+25 V to -15 V
Maximum nondestructive input signal to probe	+30 V to -20 V
Minimum signal swing	500 mV _{peak-to-peak}
Input resistance	101 k Ω
Input capacitance	8.0 pF typical
Pollution Degree	2, indoor use only
Humidity	5% to 95% relative humidity

Lock the oscilloscope

Lock an oscilloscope to a test bench or equipment rack to prevent property loss. Attach a standard laptop security lock to the rear panel of the oscilloscope, to secure the oscilloscope to a workbench, rack, or other location.

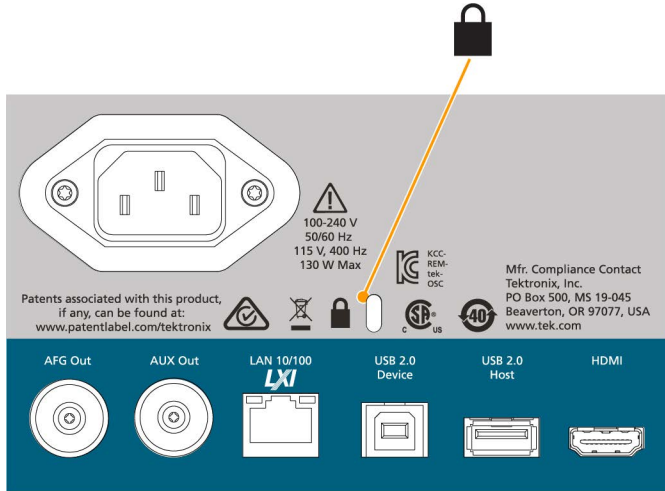

3608-003

Powering the instrument

Always connect the oscilloscope to AC power using the power cord that shipped with the instrument.

Procedure

1. Connect the supplied power cord to the instrument power connector and then connect the power cord to an appropriate AC mains source.
2. Push the front panel power button to power the instrument on and off. The button is blue when the instrument is powered on. The button color is yellow when the instrument is in standby mode and unlit when no AC power is applied.
3. To completely remove power from the instrument, disconnect the power cord.

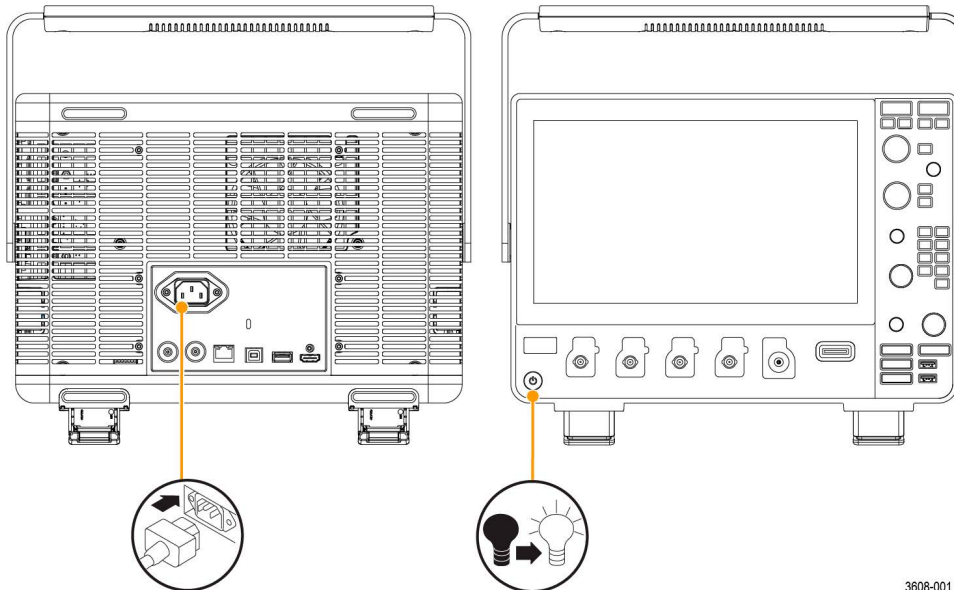

3608-001

Figure 1: Power cord connector and power standby switch

Check that the oscilloscope passes power-on self tests

Power-on self tests verify that all oscilloscope modules are working correctly after power up.

Procedure

1. Power on the oscilloscope and wait until the oscilloscope screen appears.
2. Select **Utility > Self Test** from the top-edge Menu bar to open the **Self Test** configuration menu.
3. Check that the status of all power-on self tests are **Passed**.
If one or more power-on self tests shows **Failed**:
 - a. Power cycle the oscilloscope.
 - b. Tap **Utility > Self Test**. If one or more power-on self tests still shows **Failed**, contact Tektronix Customer Support.

Connecting probes

Probes and cables connect the oscilloscope to your device under test (DUT). Use a probe that best matches your signal measurement needs.

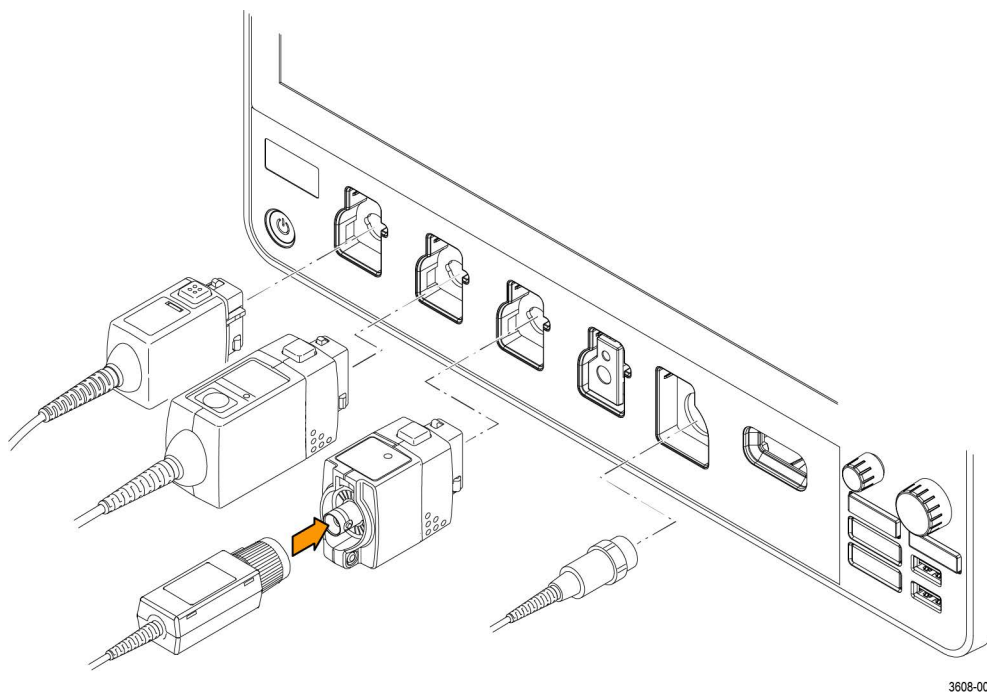

3608-002

1. **Tektronix Versatile Probe Interface (TekVPI)**. These probes support two-way communication with the oscilloscope through on-screen menus and remotely through programmable support. The remote control is useful in applications like ATE where you want the system to set probe parameters.
2. **Tektronix Versatile Probe Interface (TekVPI) for Passive Probes**. These probes build upon the functionality of the TekVPI interface. Each probe is matched with its corresponding oscilloscope channel, allowing the oscilloscope to optimize the signal input path. This provides AC compensation across the frequency band.
3. **TPA-BNC Adapter**. The TPA-BNC Adapter allows you to use TEKPROBE II probe capabilities, such as providing probe power and passing scaling and unit information to the oscilloscope.
4. **BNC Interfaces**. Some of these use TEKPROBE capabilities to pass the waveform signal and scaling to the oscilloscope. Some only pass the signal and there is no other communication.
5. **Logic Probe Interface**. The P6316 probe provides 16 channels of digital (logical one or zero) information.
6. **TPA-N-VPI Adapter**. The TPA-N-VPI Adapter allows you to use TekVPI probes with the RF input.

Connect TPP0250, TPP0500B, TPP1000, TekVPI+, TekVPI, or other supported Tektronix analog probes by pushing them into an input connector. The probe base latch locks with a 'click' when the probe is fully seated.

TekVPI probes automatically set the channel input parameters for that probe (bandwidth, attenuation, termination, and so on). If a probe has a **Menu** button, push that button to open an on-screen configuration menu. Follow instructions provided with active probes to set their parameters (auto zero, degauss, and so on).

Connect a BNC probe or cable by pushing it onto a channel BNC bayonet connector and turn the lock mechanism clockwise until it locks.

For more information on the many probes available for use with 3 Series MDO oscilloscopes, visit the Oscilloscope Probe and Accessory Selector Tool at www.tek.com.



Note: Connecting a probe does not automatically enable that channel (make it active). Use the instrument controls or programmatic interface to turn on a channel and open its configuration menu to verify or change probe or cable settings (bandwidth, attenuation, termination and so on).

Rackmount information

The optional RM3 Rackmount Kit lets you install the oscilloscope in standard equipment racks. The rack mount requires six rack units (6U) of space to install.

Contact Tektronix Customer Support to purchase the rackmount kit option RM3. Follow the instructions that come with the rackmount kit (*RM3 Rackmount Kit Instructions*).

Make sure to allow at least two inches of clearance on the sides for air ventilation and on the back for any cables you attach to the rear panel.

Remote access from a Web browser

You can remotely access your network-connected instrument from a Web browser to display the instrument user interface on a PC.

About this task

This procedure describes how to remotely access the UI controls and screen for the instrument.

Before you begin

- The oscilloscope must be connected to, and accessible from, the network to which the PC is connected. See [Connect to a network \(LAN\)](#) on page 36
- Determine the IP address of the oscilloscope that you want to access. To determine the oscilloscope's IP address, select **Utility > IO** in the oscilloscope menu bar and view the network settings in the **LAN** panel.

Procedure

1. Open a Web browser on a PC connected to the same network as the oscilloscope.
2. Enter just the oscilloscope IP address on the URL line of the browser and press **Enter**. For example: 135.62.88.157. The browser searches for and opens the Web page for the oscilloscope.
3. Select **Instrument Control (e*Scope®)**. The browser displays the instrument screen.
4. Use a mouse to select and interact with the oscilloscope controls shown in the Web browser. If your remote PC or laptop has a touchscreen monitor, you can use that to access the oscilloscope controls.

When you access the instrument from an e*Scope browser, you cannot directly paste text (such as path, IP address information, and so on) from the PC to an instrument menu field. You must use an intermediate clipboard function that is available in the e*Scope application.

Use the following steps to copy text from an e*Scope-connected PC to the instrument:

- a. Open a connection to the instrument using **e*Scope**.
- b. Select and copy the text on your PC.

- c. In e*Scope, press **Ctrl-Alt-Shift** to open the **Clipboard** menu.
- d. Paste the text into the Clipboard field.
- e. Press **Ctrl-Alt-Shift** to close the browser Clipboard menu
- f. Use e*Scope to open the instrument menu to which to paste content and position the cursor in the field where you want to paste the text.
- g. Press **Ctrl-V** (on real keyboard or from virtual keyboard) to paste the text from the e*Scope browser clipboard to the menu field.
- h. Repeat steps [4.b](#) on page 16 through [4.g](#) on page 17 to copy and paste other text from the PC to the instrument.

Connect the oscilloscope to a PC using a USB cable

Use a USB cable to connect the oscilloscope directly to a PC for remote instrument control.

Procedure

1. On the oscilloscope, select **Utility > I/O** from the menu bar.
2. Tap **USB Device Port**.
3. Confirm that the USB Device Port control is **On** (default setting).
4. Connect a USB cable from the PC to the USB **Device** port on the rear of the instrument.
5. If using the USB connection to remotely control the oscilloscope using GPIB adapter (TEK-USB-488), set the **GPIB Talk/Listen Address** for your configuration (0 - 30).

Cleaning

Use a dry, soft cotton cloth to clean the outside of the unit. If any dirt remains, use a cloth or swab dipped in a 75% isopropyl alcohol solution. Use a swab to clean narrow spaces around controls and connectors. Do not use any liquid cleaning agents or chemicals that could damage the touchscreen, case, controls, markings or labels, or possibly infiltrate the case.

Getting acquainted with your instrument

The following content provides a high-level description of the instrument controls and user interface. Refer to the instrument help for detailed information on using the controls and user interface to display waveforms and take measurements.

Front panel controls and connectors

The front panel controls provide direct access to key instrument settings such as vertical, horizontal, trigger, and cursors. The connectors are where you input signals with probes or cables or insert USB devices.



Note: Refer to the instrument help for detailed information on using the controls to display waveforms and take measurements.

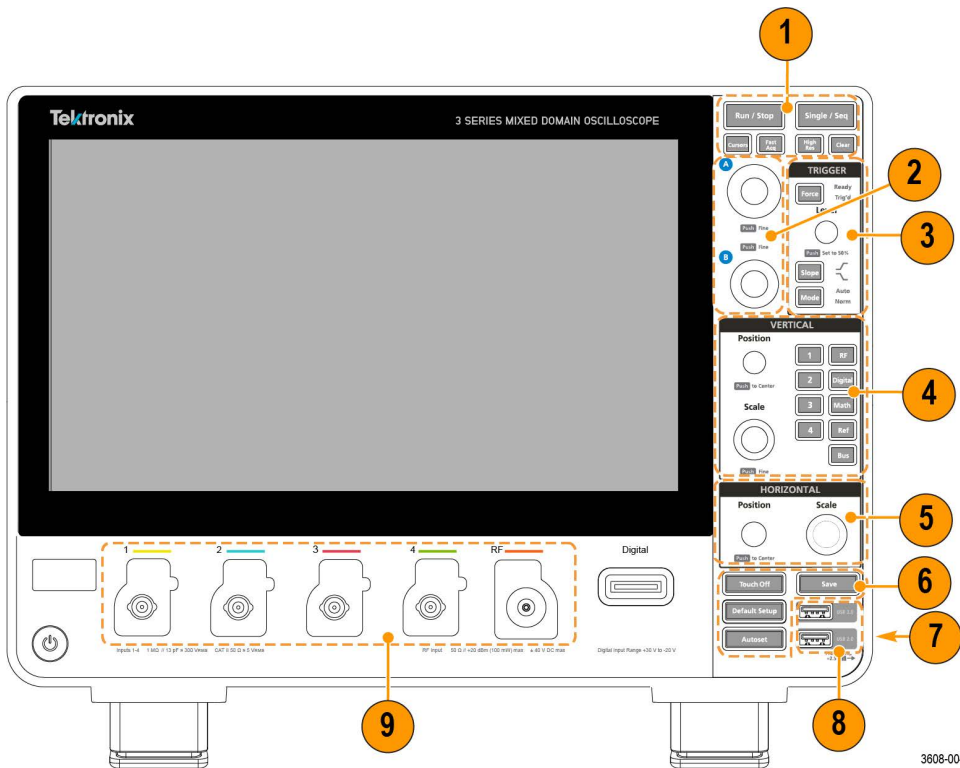

1. Use the **Acquisition** and **Cursors** controls to start and stop waveform acquisition, turn cursors on or off, enable or disable the fast acquisition mode, enable making a single waveform acquisition, calculate the average of all the samples for each acquisition interval, and delete the current acquisitions and measurement values from memory.
2. Use the **Multipurpose Knobs (A, B)** to move cursors, adjust the zoom, and set parameter values in configuration menu input fields.
3. Use the **Trigger** controls to force a trigger event at a random point in the waveform and captures the acquisition, set the amplitude level that the signal must pass through to be considered a valid transition, set the signal transition direction to detect for a trigger, and set how the instrument behaves in the absence or presence of a trigger event.
4. Use the **Vertical** controls to move the selected waveform up or down on the screen, set the amplitude units per vertical graticule division of the selected waveform, turn on (display) or select channels, and add or select a math, reference (saved), bus, RF, and digital waveform on the Waveform view.
5. Use the **Horizontal** controls to move the waveform from side to side on the screen, and set the time per major horizontal graticule division and samples/second parameters for the oscilloscope.
6. Use the Miscellaneous controls to turn touchscreen capability off, restore the oscilloscope settings to the default settings, automatically display a stable waveform, and save files or settings (using the current File > Save As settings).

7. Use Ground and probe compensation connectors to provide a ground connector to help reduce electrostatic damage (ESD) and adjust the high-frequency response of a passive probe. The Ground and Probe Compensation connectors are located at the lower right side of the instrument, near the front panel.
8. USB ports are located at the lower right corner of the front panel and on the rear panel. Connect USB flash drives to which you can save or recall data (such as instrument software updates, waveforms, settings, and screen captures) or connect peripheral devices such as a mouse or keyboard.
9. Use the Probe connectors to connect TekVPI+ and TekVPI measurement probes, BNC passive probes, the P6316 Logic Probe, and BNC cables.

Rear panel connections

The rear panel connections supply power to the oscilloscope and provide connectors for network, USB devices, video, reference signals, and the AFG output.

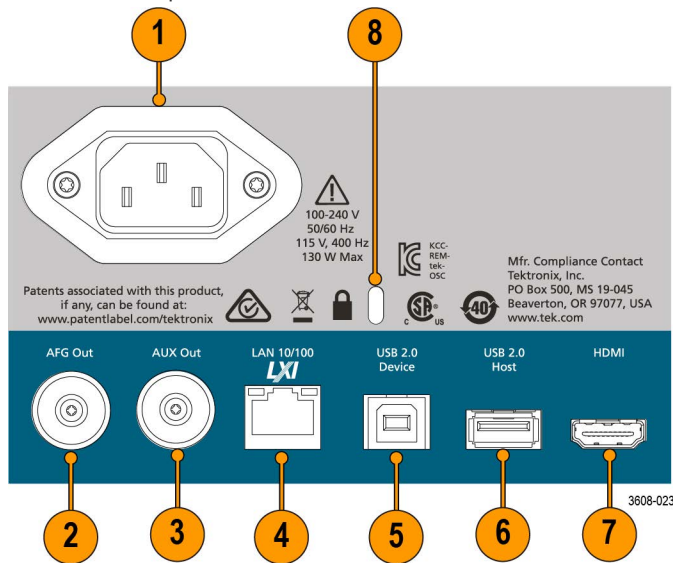

1. **Power cord** connector. Use only the power cord specified for this product and certified for the country of use.
2. **AFG Out** is the signal output for the optional Arbitrary Function Generator (AFG) feature.
3. **AUX Out** generates a signal transition on a trigger event or outputs a synchronization signal from the AFG.
4. **LAN** connector (RJ-45) connects the oscilloscope to a 10/100 Base-T local area network.
5. **USB Device** port lets you connect to a PC to remotely control the oscilloscope using the USBTMC protocol.
6. **USB Host** port lets you connect a USB memory device, keyboard, or mouse.
7. **HDMI** output lets you connect an external monitor or projector to show the oscilloscope screen.
8. **Security** lock connector lets you use a standard PC/laptop lock cable to secure the oscilloscope to a work bench or other location.

User interface

The touchscreen user interface contains waveforms, measurement readouts, and touch-based controls to access all oscilloscope functions.

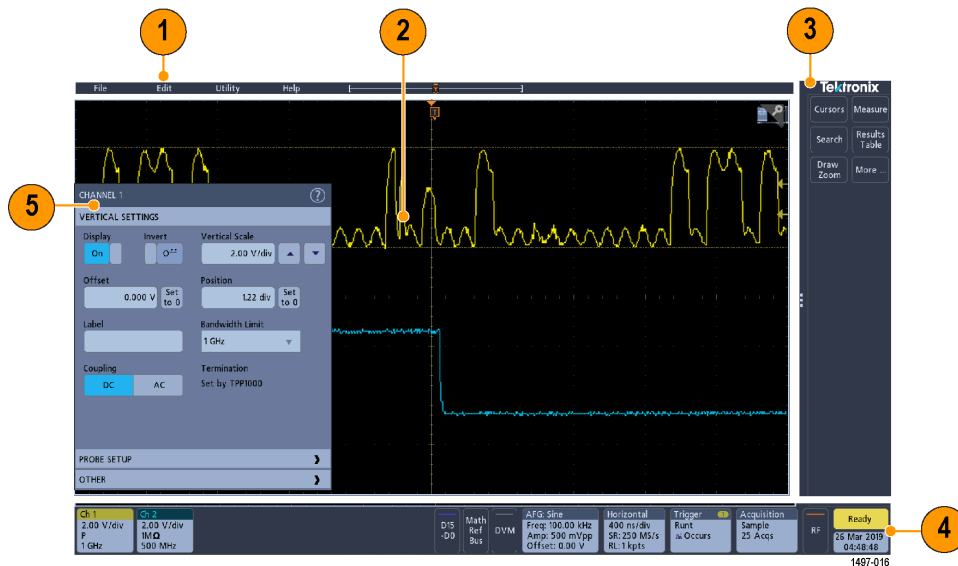

1. The **Menu bar** provides menus for typical operations including:
 - Saving, loading, and accessing files
 - Undoing or redoing an UI action
 - Setting oscilloscope display and measurement preferences
 - Configuring network access
 - Running self tests
 - Erasing measurement and settings memory (TekSecure™)
 - Loading option licenses
 - Opening a Help viewer
2. The **Waveform View** area displays analog, digital, math, reference, and bus waveforms. The waveforms include waveform handles (identifiers), trigger position, and level(s) indicators. See [Identifying items in the time domain display](#) on page 21.
3. The **Results Bar** contains controls for displaying cursors, adding result tables to the screen, and adding measurements to the Results bar. The controls are:
 - The **Cursors** button displays on-screen cursors. Touch and drag or use the Multipurpose knobs to move the cursors. Double-tap on a cursor or on the cursor readouts to open a configuration menu to set cursor types and related functions.
 - The **Measure** button opens a configuration menu from which to select and add up to four measurements to the Results bar. Each measurement you add has a separate badge. Double-tap a measurement badge to open its configuration menu.
 - The **Search** button lets you detect and mark a waveform where specified events occur. Tap **Search** to open a Search configuration menu and set the search conditions for analog and digital channels. Search badges are added to the **Results Bar**.
 - The **Results Table** button adds a Measurement, Bus, Search, and Harmonics results table to the screen. The Measure tab displays all measurements present in the Results bar. The Bus tab displays bus decode information for displayed bus waveforms. The Search tab displays search event information. The Harmonics tab displays harmonic measurement results.
 - The **More...** button on the **Results Bar** allows you to select Zoom or Mask.
 - The **Draw Zoom/Mask** button lets you to draw a mask or zoom. This button reflects the function selected in **DRAW A BOX** menu.
 - The **Measurement** and **Search** badges show measurement and search results and are displayed in the **Results Bar**.

- The **Settings Bar** contains System badges for setting Horizontal, Trigger, Acquisition, and Date/Time parameters; **Inactive Channel** buttons to turn on channels; **Math/Ref/Bus** button to add math, reference, and bus waveforms to the display; and Channel and Waveform badges that let you configure the individual waveform parameters. Tap a channel or waveform button to add it to the screen and display a badge. Double-tap a badge to open its configuration menu.
- Configuration Menus** let you quickly change the parameters of the selected user interface item. You can open configuration menus by double-tapping on badges, screen objects, or screen areas.

Identifying items in the time domain display

Each area of the user interface has a specific function that helps manage information or controls. This topic shows and describes the key user interface elements.

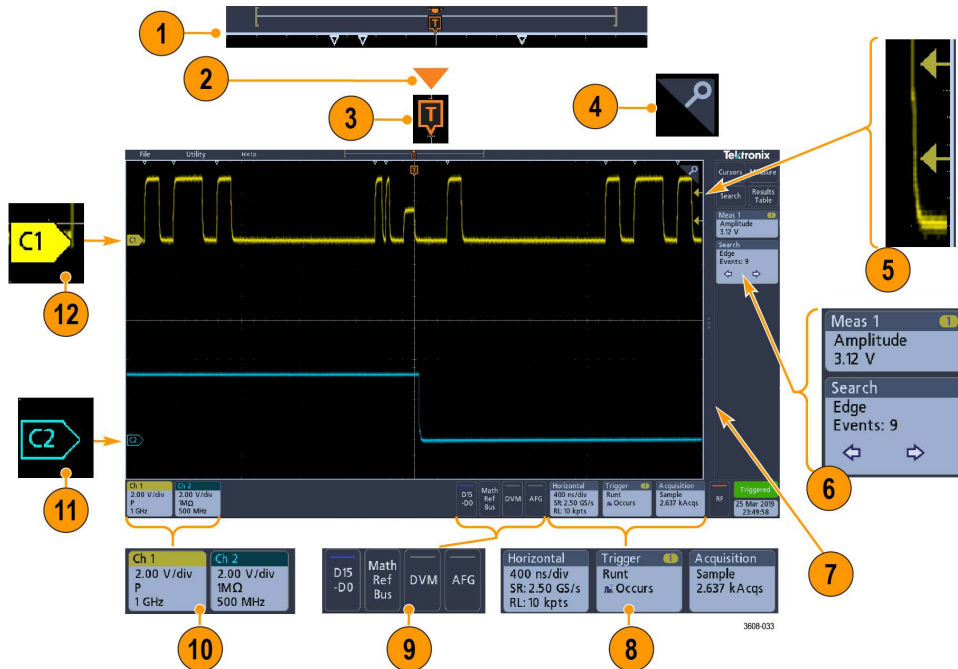

- The Waveform Record View is a graphical high-level view of the overall acquisition, how much of the acquisition is on the screen (shown in brackets), the location of key time events including the trigger event, and the current position of waveforms cursors.



If you are changing the horizontal time scale while the oscilloscope acquisition is stopped, the brackets change position to show the part of the waveform record that is being viewed relative to the current acquisition total record length.

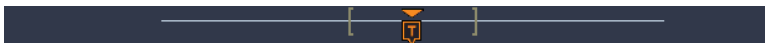

If cursors are active on a waveform, the Waveform Record View shows the relative cursor positions as small vertical dashed lines.



When in Zoom mode, the Waveform Record View is replaced with the Zoom Overview. See [Zoom user interface](#) on page 31.

- The Expansion Point icon on the waveform view shows the center point around which the waveform expands and compresses when changing horizontal settings.



- The Trigger Position Indicator shows where the trigger event occurred in the waveform record.



4. The Zoom icon (in upper right corner of Waveform and Plot views) toggles zoom on and off.



5. The Trigger Level Indicator icon(s) shows the trigger level(s) on the trigger source waveform. Some trigger types require two trigger levels.
6. Measurement and Search badges show measurement and search results. See [Badges](#) on page 25.
7. The Results Bar Handle opens or closes the **Results bar** to maximize waveform screen viewing when needed. To reopen the **Results bar**, either tap the handle icon or swipe left from the right side of the display.
8. The System badges show global instrument settings (**Horizontal**, **Trigger**, **Acquisition**, Run/Stop status, and Date/Time). See [Badges](#) on page 25.
9. The Inactive Channel buttons add channel waveforms to the Waveform view and add an associated Channel badge to the Settings bar.

The **Add Math Ref Bus** button expands allowing you to add a math, reference, or bus waveform to the Waveform view and add an associated Waveform badge to the **Settings** bar.

The **RF** button activates the frequency domain display and adds an RF badge. Double-tap the badge to open the RF configuration menu to configure the RF input. This button is only active if one of the RF options is enabled.

The **AFG** button opens the AFG configuration menu to set and enable the AFG output. This button is only present if the AFG option is installed.

The **DVM** button lets you use an analog probe to take DC, AC RMS, or DC+AC RMS voltage measurements on your DUT. Tap the button to add a DVM badge to the Results Bar and open a configuration menu. The DVM option also enables a trigger frequency counter, accessible from the **Mode & Holdoff** panel in the **Trigger** badge menu. This button is only present if the DVM option is installed.

10. Double-tap a badge to open its associated configuration menu. See [Badges](#) on page 25. See [Configuration menus](#) on page 29.

If you add more Channel or Waveform badges than can fit in the waveform badge display area, tap the scroll buttons at each end of the waveform badge area to scroll and display hidden badges.

11. The Waveform Handles on each waveform identify the source of that waveform (Cx for channels, M for Math, Rx for Reference waveforms, Bx for bus waveforms). The waveform handles are at the zero-volt level of the waveform by default. The currently selected waveform handle is a solid color; unselected waveform handles are outlined.

Double-tapping a waveform handle opens the configuration menu for that waveform.

For digital channels, the waveform handle shows the channel number, with each individual digital signal labeled D0–D15 and displayed with a different color.

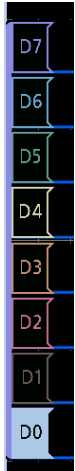

Double-tapping a digital waveform handle opens the digital channel configuration menu.

Dragging a digital signal handle over another handle swaps location of the signals in the waveform view. Dragging a digital signal handle out of the group, creates a new group. A selected digital group or signal handle can be moved using the Vertical Position control.

Identifying items in the frequency domain display

To activate the frequency domain display, press the front panel RF button or tap the RF button in the display. Each area of the user interface has a specific function that helps manage information or controls.

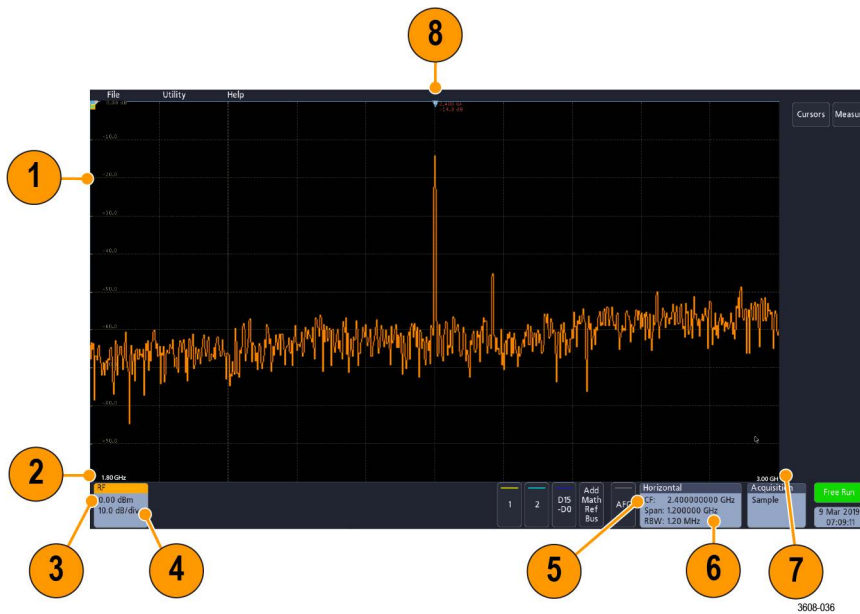

1. Vertical graticule labels
2. Start frequency
3. Reference level
4. Vertical scale
5. Center frequency
6. Span and resolution bandwidth
7. Stop frequency

8. Reference marker
9. Displayed trace indicators

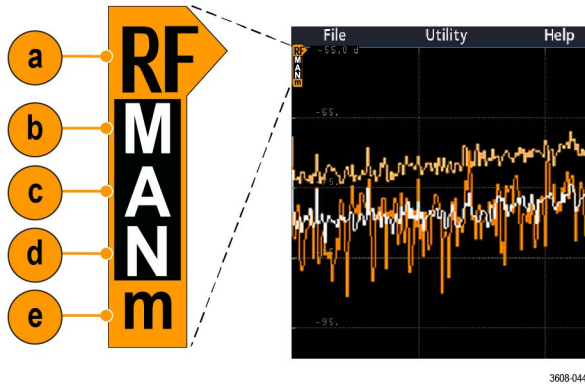

- a. An RF trace indicator is placed at the Reference Level.
- b. A capital M appears if the maximum trace is turned on.
- c. A capital A appears if the average trace is turned on.
- d. A capital N appears if the normal trace is turned on.
- e. The small m appears if the minimum trace is turned on.

Orange highlighting indicates the currently selected trace. In the figures the small m, which stands for the minimum trace, is highlighted. This indicates that the minimum trace is currently selected.

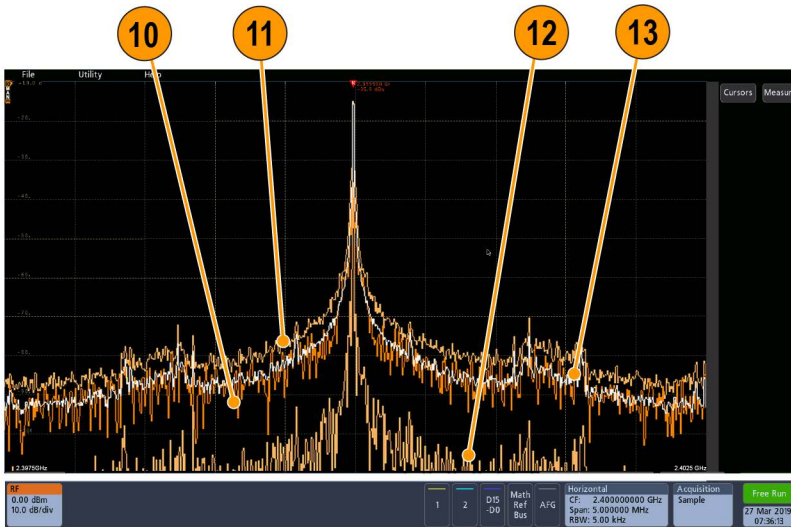

10. Normal trace: Each acquisition is discarded as new data is acquired.
11. Max hold trace: The maximum data values are accumulated over multiple acquisitions of the Normal trace.
12. Min hold trace: The minimum data values are accumulated over multiple acquisitions of the Normal trace.
13. Average trace: Data from the Normal trace is averaged over multiple acquisitions. This is true power averaging, which occurs before the log conversion. Each power of 2 averaging reduces the displayed noise by 3 dB.

Badges

Badges are rectangular icons that show waveform, measurement, and instrument settings or readouts. Badges also provide fast access to configuration menus. The badge types are Channel, Waveform, Measurement, Search, and System.

Channel and Waveform badges

Channel and Waveform (**Math, Ref, Bus**) badges are shown in the **Settings** Bar, located along the bottom left of the screen. Each waveform has its own badge. The badges show high-level settings for each displayed channel or waveform. Double-tap a badge to open its configuration menu.

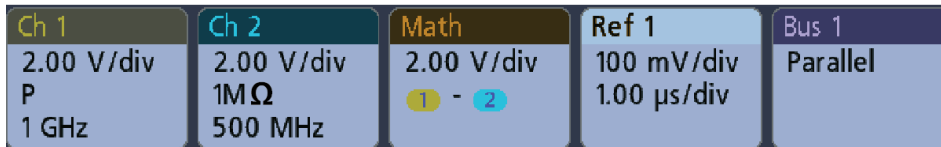

1497-013

Most Channel and Waveform badges also have Vertical Scale buttons, shown by single-tapping the badge. Use these buttons to increase or decrease the vertical scale setting for that waveform.



You can drag or flick Channel and Waveform badges down off the display to turn them off. Swiping back up from the bottom of the display restores them if they were accidentally deleted.

Channel badges are listed in the channel order. For more information, double-tap the badge to open its configuration menu or search the instrument Help.

Measurement badges

Result badges are located in the **Results** Bar. They show measurement or search results. The badge title also shows the measurement source or sources. To add a Measurement badge, tap the **Measure** button, select a measurement, and tap **Add**.

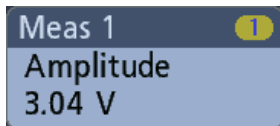

Double-tap a Measurement badge to open its configuration menu to change or refine settings.

Some measurements and their badges are only available as options. For example, Power measurements are only listed in the Add Measurement menu if the PWR option is installed.

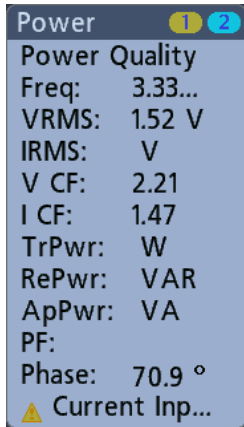

To add statistical readouts to individual measurement badges, double-tap a measurement badge to open its configuration menu and select **Show Statistics in Badge**.

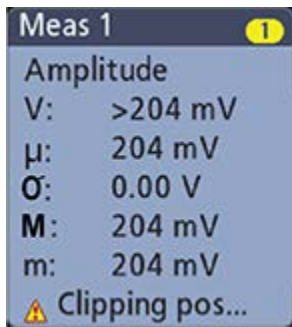

You can drag or flick Measurement badges off to the right of the display to delete them. You can bring the badge back by swiping in from the right.

Mask Test Badge

The mask test results and measurement statistics are displayed in the Mask Test badge in the Results bar. The badge is created when the first segment of a mask is defined.



Badge readout	Description
Label	A label defined in the badge configuration menu.
Wfms	The total number of waveforms tested against the mask.
Failed	The number of waveforms that contained one or more samples that violated the mask.
Hits (optional readout)	A row is created for each segment that makes up the mask. The number displayed is the number of times that segment has been hit.
Total	The total number of hits on all segments.
Status	The status of the mask test. Either Pass (green) or Fail (red) is displayed.

Double-tap a Mask Test badge to open its configuration menu to change or refine settings.

You can drag the badge to change its position in the Results bar and open the badge right click menu to access a quick-action menu.

There are two ways to delete Channel and Waveform badges.

- Right-click the badge and turn it off.
- Flick the badge off the right edge of the display to remove it from the Results bar. Flicking left from the right edge of the Results bar recovers the badge. Badge recovery is only possible within 10 seconds of removal.

See for the mask test configuration settings [Create a Mask](#) for more information masks and [Mask Test badge configuration menu](#).

Search badges

Search badges are also shown in the Results Bar, below the Measurement badges. A search badge lists the search source, search type, and the number of search event occurrences in the current acquisition. The instrument marks the waveform where those events occur with small down-pointing triangles along the top of the waveform graticule. Double-tap a search badge to open its configuration menu to change or refine search settings.

Search badges are created by tapping the **Search** button. Use the displayed configuration menu to set the search criteria.

Search badges have < (Previous) and > (Next) Navigation buttons that open the Zoom mode and center the waveform in the display at the position of the previous or next search mark in the waveform record. Search badge Navigation buttons are only usable when acquisitions are stopped.



You can drag or flick a Search badge to the right, off the display, to delete it. You can bring the badge back by swiping in from the right.

Signal clipping and badges

Clipping causes inaccurate amplitude-related measurement results. Clipping also causes inaccurate amplitude values in saved waveform files. If a math waveform is clipped, it will not affect amplitude measurements on that math waveform.



WARNING: Clipping is caused by excessive or dangerous voltages at the probe tip and/or a vertical scale setting that is not adequate to display the entire vertical range of the waveform. Excessive voltage at the probe tip can injure the operator and cause damage to the probe and/or instrument.

This instrument shows a warning triangle symbol and the word Clipping in a Channel badge when a vertical clipping condition exists. Any measurement badges associated with that channel also indicate a clipping condition.



To close the clipping message, change the vertical scale to show the entire waveform, disconnect the probe tip from the excessive voltage source, and check that you are probing the correct signal using the correct probe.

Error messages and badges

This instrument shows a warning triangle symbol and an error message abbreviation in a Channel badge when an error occurs.



To remove the message from the badge, clear the error.

System badges

System badges (in the **Settings** bar) display the main Horizontal, Trigger, and Acquisition settings. You cannot delete System badges.

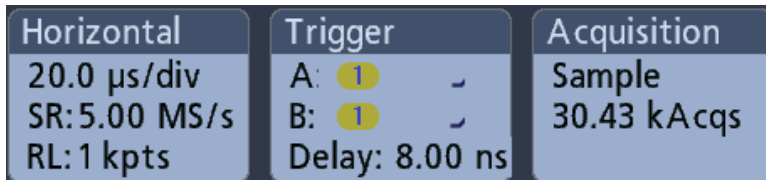



Double-tap a System badge to open its configuration menu.

The Horizontal badge also has Scale buttons, shown by single-tapping the badge. Use the Horizontal Scale buttons to increase or decrease the horizontal time/div setting.

Common badge actions

Action	Result	Example
Single tap	Immediate access controls (Scale, Navigation).	

Table continued...

Action	Result	Example
Double tap	Configuration menu with access to all settings for the badge.	
Touch and hold	Right-click menu with single tap access to common actions. Typical actions include turning off a channel and deleting a measurement or search badge.	

Configuration menus

Configuration menus let you quickly set the parameters for channels, system settings (Horizontal, Trigger, Acquisition), measurements, cursor readouts, Waveform view, and so on.

Double-tap an item (badge, **Waveform View**, cursor readouts, and so on) to open its configuration menu. For example, double-tap a Channel badge in the **Settings Bar** to open its configuration menu.

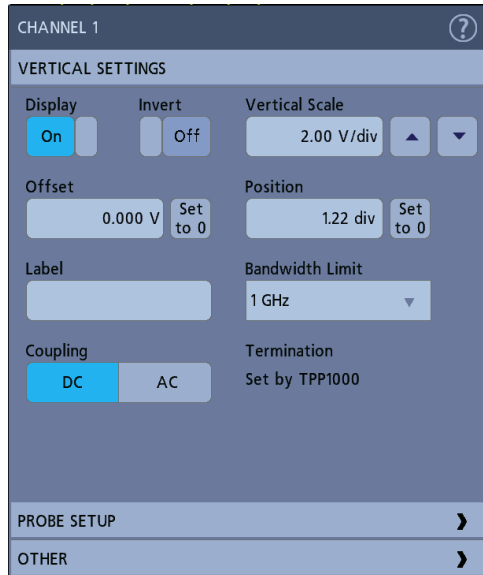

Selections or values that you enter take effect immediately. Menu contents are dynamic and can change depending on your selections, instrument options, or attached probes.

Related settings are grouped into 'panels.' Tap the panel name to show those settings. Changes to panel settings can change the values and/or fields shown in that panel and other panels.

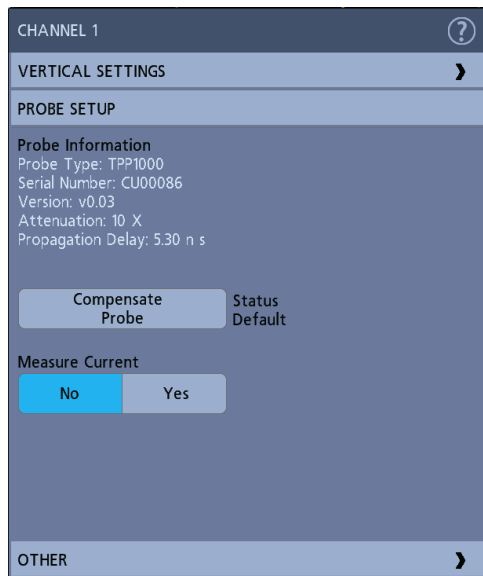

Tap anywhere outside a configuration menu to close it.

To open Help content for a configuration menu, tap the question mark icon in the upper right corner of the menu.

Zoom user interface

Use the zoom tools to magnify waveforms to view signal details.

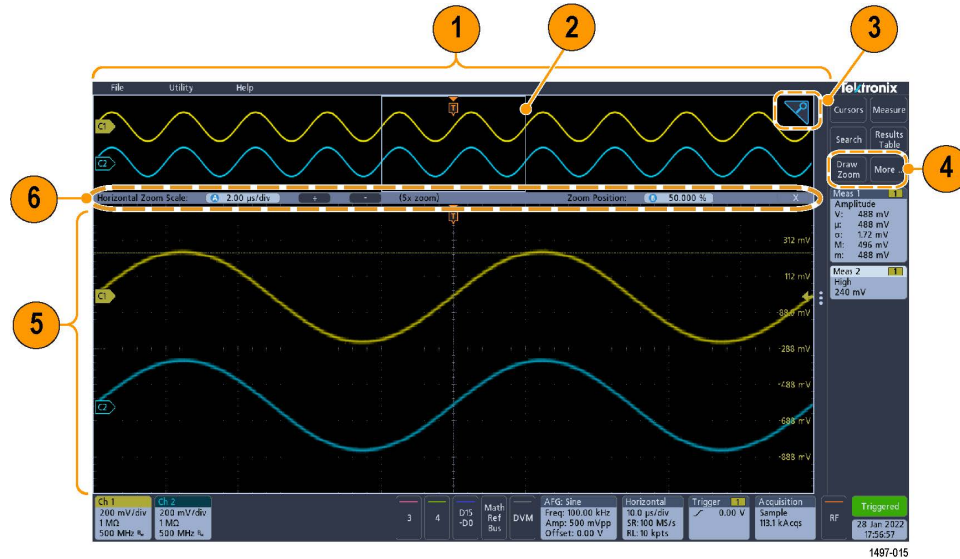

1. The **Zoom Overview** shows the entire waveform record. Use pinch and expand gestures on the Zoom Overview waveforms to change the horizontal time base settings.
2. The **Zoom Box** shows the area of the Zoom Overview to display in the Zoom View (see 5 on page 31). You can touch and drag the box to move the area to view. Moving the Zoom Box or changing its position does not change the horizontal time base settings.
3. The **Zoom** icon (in the upper right corner of the Waveform View) switches zoom mode on and off.
4. The **DRAW A BOX** menu has an option to toggle between drawing a zoom box (default mode) and drawing segments for Mask Testing.

A zoom box lets you quickly draw a box around an area of interest in the Waveform or Zoom Overview. Drawing a box immediately puts the oscilloscope into zoom mode. To draw a zoom box, tap the **Draw Zoom** button while in Zoom mode in the **DRAW A BOX** menu, then touch and drag on the waveform to draw a box waveform. You can continue to draw zoom boxes until you single tap anywhere on the screen or open a menu.

To toggle between **Zoom** mode and **Mask** mode, tap the **More** button and select one of the two options in the **DRAW A BOX** menu.

5. The **Zoom View** shows the zoomed waveforms as marked by the Zoom Box. Use pinch and/or drag options in the zoom view to change the zoomed area of interest. Pinch, expand, and drag gestures in the Zoom View only change zoom magnification settings and Zoom Box position.
6. Use the **Zoom Title Bar** controls to adjust the horizontal size and the position of the zoom area. Click or tap the + or - buttons or use the A and B multipurpose knobs. Double tap the zoom scale and position fields to enter a value using a numerical keypad. Touch the **Zoom Position** or **Horizontal Zoom Scale** fields before using the multipurpose knobs to adjust the zoom.

Using the touchscreen interface for common tasks

Use standard touchscreen actions, similar to those found on smart phones and tablets, to interact with most screen objects. You can also use a mouse to interact with the UI. The equivalent mouse operation is shown for each touch operation.

Table 3: Common touchscreen UI tasks (with mouse equivalents)

Task	Touchscreen UI action	Mouse action
Add a channel, math, reference, or bus waveform to the screen.	Tap an inactive channel button or the Add Math Ref Bus button and select a math, reference, or bus.	Click an inactive channel button or the Add Math Ref Bus button and select a math, reference, or bus.
Select a channel, math, reference, or bus waveform to make it active.	Tap the Channel or Waveform badge or waveform handle.	Click the Channel or Waveform badge or waveform handle.
Display scale or navigation buttons on a badge (waveform, measurement ¹ , search, horizontal).	Tap the badge.	Click the badge.
Open a configuration menu on any item (all badges, views, cursor readouts, labels, and so on).	Double-tap the badge, view, or other object.	Double-click the badge, view, or other object.
Open a right-click menu (badges, views).	Touch and hold on the badge, Waveform View, or other screen item until a menu opens.	Right-click the object.
Close a configuration menu ² .	Tap anywhere outside the menu or dialog.	Click anywhere outside the menu or dialog.
Move a menu.	Touch and hold the menu title bar or a blank area in the menu, then drag the menu to new position.	Click and hold the left mouse button on title or blank area and then drag to new position.
Change horizontal or vertical settings directly on a waveform. Vertical changes only apply to the selected channel or waveform; horizontal changes apply to all channels and waveforms.	Tap a badge and use the Scale buttons. Or, use pinch/expand gestures.	Click a channel, waveform, or Horizontal badge and click on the Scale buttons.
Increase or decrease the zoom area (while in Zoom mode).	Touch and hold two fingertips on the waveform view, move them together or apart vertically or horizontally, lift from screen, and repeat.	Click and drag the zoom area. Click the + or - buttons on the Zoom Title bar.
Adjust the zoom position (while in Zoom mode).	Touch and drag in the zoom area to adjust the position of the zoom.	Click and drag in the zoom area to adjust the position of the zoom.
Quickly scroll or pan a waveform.	Touch and drag in the waveform.	Click and drag in the waveform or list.
Close or open the Results Bar to increase the Waveform View area.	Tap on the Results Bar Handle or anywhere in the border between the Waveform View and the Results Bar .	Click the Results Bar Handle or anywhere in the border between the Waveform View and the Results Bar . Click and drag the Results Bar divider.

¹ Not all measurement or search badges display navigation buttons.

² Some dialog boxes will not close until you click an OK, Close, or other button in the dialog.

Configure the instrument

Configurations to help operate your instrument efficiently. Refer to the instrument help for additional configuration information.

Set the date and time

Set the date and time so that saved files are marked with the correct date and time information.

Procedure

1. Double-tap the **Date/Time** badge (bottom-right of screen) to open the configuration menu.

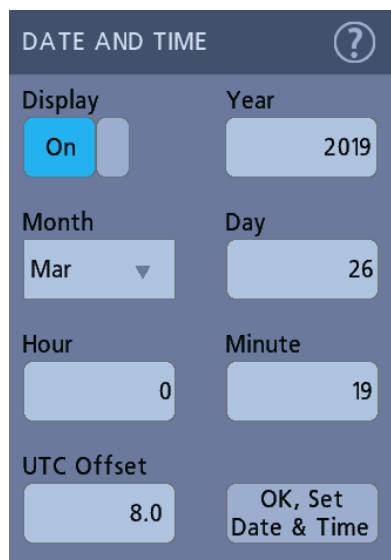

2. To turn off showing the date and time on the screen, tap the **Display** button to **Off**.
To turn on date/time display again, double-tap in the blank area where the date/time badge was displayed to open the configuration menu and set the **Display** button to **On**.
3. You may also tap the **Year**, **Day**, **Hour**, **Minute**, or **UTC Offset** fields and use the multipurpose knobs to set the fields to the correct time.
You may also double-tap the fields and use the numeric keypad to set the time.
4. Tap **Month** and select the month from the list.
5. Tap anywhere outside of the menu to close it.

Download and install the latest firmware

Installing the latest firmware helps ensure that your instrument is equipped with all of the best available measurement and analysis improvements.

Before you begin

Save any important on-instrument files (waveforms, screen captures, oscilloscope setups, and so on) to a USB drive or network. The installation process does not remove user-created files, but it is a good idea to back up important files before an update.

Determine the current version of firmware installed on the oscilloscope. The version number is found in the **About** window under the **Help** menu on most instruments.

Procedure

1. Open up a Web browser on a PC and go to **www.tek.com/product-support**.
2. Enter the oscilloscope model number in the search field and click **Go**.
3. Scroll down the screen and click the **Software** tab.
4. If the listed available firmware version is newer than what is on your oscilloscope, select and download that file to your PC.
5. Copy the firmware install file to a USB drive.
6. Follow the instructions that are provided with the firmware to create the install files.
7. Insert the USB flash drive into any USB Host port on your instrument. The instrument automatically recognizes the firmware file and starts the installation process.
8. Follow on-screen instructions. The instrument will take a few minutes to install the new firmware. Do not remove the USB flash drive or power off the instrument during this time.
9. After the upgrade is complete, power off the instrument and remove the USB flash drive.
10. Power on the instrument.
11. To confirm the firmware update, locate the version number found in the **About** window under the **Help**.
12. Confirm that the instrument firmware version number matches the firmware version number that you just installed.

Run Signal Path Compensation (SPC)

Run SPC at regular intervals for best measurement accuracy. You should run SPC whenever the ambient (room) temperature has changed by more than 5 °C (9 °F) or once a week if you use vertical scale settings of 5 mV/div or less.

About this task

Signal Path Compensation (SPC) corrects for DC level inaccuracies in the internal signal path caused by temperature variations and/or long-term signal path drift.

Failure to run SPC on a regular basis may result in the oscilloscope not meeting warranted performance levels at low volts per division settings.

Before you begin

Disconnect all probes and cables from the front-panel channel inputs and rear-panel signal connectors.

Procedure

1. Power on and warm up the oscilloscope for at least 20 minutes.
2. Tap **Utility > Calibration**.
3. Tap **Run SPC**. The **SPC Status** readout shows **Running** while SPC is running. SPC can take several minutes per channel to run, so wait until the SPC Status message changes to Pass before reconnecting probes and using the oscilloscope.
4. Close the **Calibration** configuration dialog when SPC has completed.
5. If SPC fails, write down any error message text. Make sure that all probes and cables are disconnected and run SPC again. If SPC still fails, contact Tektronix Customer Support.

Compensate TPP0250, TPP0500B, or TPP1000 probes

Probe compensation adjusts the high frequency response of a probe for best waveform capture and measurement accuracy. The oscilloscope can automatically test and store compensation values for TPP0250, TPP0500B and TPP1000 probes.

About this task

The oscilloscope stores the compensation values for each probe/channel combination and automatically recalls the compensation values when you plug in the probe again. Probe compensation status is shown in the Probe Setup panel of the Channel configuration menu.

- If the Probe Compensation Status field displays **Pass**, the probe is compensated and ready for use.
- If the Probe Compensation Status field displays **Default**, the attached probe has not been compensated and needs to have this probe compensation procedure run.
- If the Probe Compensation Status field displays **Fail**, the attached probe has failed the probe compensation procedure. Reconnect the probe and run probe compensation again.
- If there is no probe compensation status field shown in the panel, the oscilloscope cannot store compensation values for that probe. See the oscilloscope Help for how to manually compensate passive probes not supported by the probe compensation function.
- Each compensation generates values for a specific probe and channel combination. If you want to use the probe on another channel and desire to compensate the new probe-channel pair, you must run a new set of compensation steps.
- Each channel can store compensation values for 10 individual probes. If you try to compensate an 11th probe on a channel, the oscilloscope will delete the values for the least recently used probe and add the values for the new probe.

Use this procedure to compensate a TPP0250, TPP0500B, TPP1000, or other supported TPP-family probe that shows a **Default** status when connected to the oscilloscope.



Note: A **Default Setup** does not delete probe compensation values. A factory calibration deletes all stored probe compensation values.

Before you begin

The oscilloscope must be powered on for at least 20 minutes before compensating a probe.

Procedure

1. Connect a supported probe to an input channel.
2. Connect the probe tip and ground lead of the probe to the PROBE COMP terminals on the lower right of the oscilloscope (see following image).

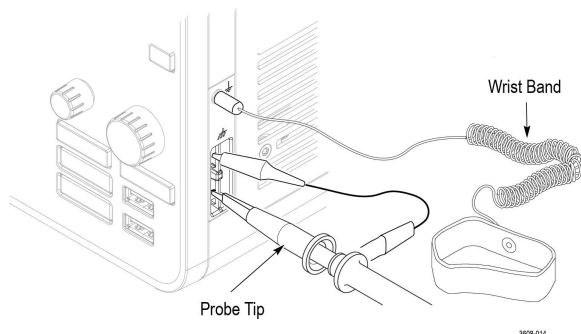

Figure 2: Probe Comp connections.

Connect the probe tip to the 1 kHz source and the ground clip to the ground. For best results, remove any probe tip accessories and hold the probe tip directly onto the 1 kHz connector.



Note: Connect only one probe at a time to the PROBE COMP terminals.

3. Turn off all channels.
4. Turn on the channel to which the probe is connected.
5. Push the front-panel **Autoset** button. The screen displays a square wave.
6. Double-tap the badge of the channel that you want to compensate.
7. Tap the **Probe Setup** panel.

If the Probe Compensation Status says **Pass**, the probe is already compensated for this channel. You can move the probe to another channel and start again from step 1 or connect a different probe to this channel and start from step 1.

If the Probe Compensation Status says **Default**, continue with this procedure.

8. Tap **Compensate Probe** to open the **Probe Compensation** dialog.
9. Tap **Compensate Probe** to run the probe compensation.
10. The probe compensation is finished when the Probe Compensation Status displays **Pass**. Disconnect the probe tip and ground from the PROBE COMP terminals.
11. Repeat these steps for each supported passive probe that you want to compensate for this channel.
12. Repeat these steps to compensate supported probes on other channels of the oscilloscope.



Note: For most accurate measurements, open the **Probe Setup** panel and verify the Probe Compensation Status is **Pass** whenever you attach a probe to a channel.



Note: A probe compensation failure is most likely due to intermittent connection of the probe tip or ground connection during the probe compensation operation. If a failure occurs, the oscilloscope will re-use the old probe compensation values if they existed prior to the failed probe compensation operation.

Connect to a network (LAN)

Connecting to a network allows you to remotely access the instrument.

Before you begin

Work with your network administrator to obtain the required information to connect to your network (IP address, Gateway IP address, Subnet Mask, DNS IP address, and so on).

Procedure

1. Connect a CAT5 cable from the oscilloscope LAN connector to your network.
2. Select **Utility > I/O** on the menu bar to open the I/O configuration menu.
3. Tap the **LAN** panel
4. Obtain or enter the network address information:
 - If your network is DHCP-enabled and the IP address field does not already show an address, tap **Auto** to obtain the IP address information from the network. DHCP mode is the default mode.
 - If your network is not DHCP-enabled or you need a static (non-changing) IP address for this instrument, tap **Manual** and enter the IP address and other values provided by your IT or system administrator resource.
5. Tap **Test Connection** to verify that the network connection is working. The LAN Status icon turns green when the instrument successfully connects to your network. If you have problems connecting to your network, contact your system administration resource for help.

Index

A

- A knob [18](#)
- Acquisition controls [18](#)
- Add
 - Bus waveform button [21](#)
 - Math waveform button [21](#)
 - Ref waveform button [21](#)
- add measurement statistical readouts to badge [25](#)
- AFG
 - option [21](#)
- AFG Out (rear panel) [19](#)
- automatic probe compensation (TPP250, TPP0500B, TPP1000) [34](#)
- Autoset
 - button [18](#)
- AUX Out
 - rear panel [19](#)
- avoid pinching when rotate handle [11](#)

B

- B knob [18](#)
- badge types [25](#)
- badges [25](#)
- Bus button [18](#)

C

- cable lock [19](#)
- channel badge [25](#)
- Channel buttons (front panel) [18](#)
- Clear button [18](#)
- clipping message [25](#)
- common touchscreen UI tasks [32](#)
- compensate TPP250, TPP0500B, TPP1000 probes [34](#)
- configuration menus [29](#)
- connect lock cable [14](#)
- connect to a network [36](#)
- connecting probes [15](#)
- correct handle rotate [11](#)
- Cursors button [18](#)
- Cursors button (touchscreen) [20](#)

D

- Default Setup button [18](#)
- documentation [10](#)
- DVM option [21](#)
- dynamic range limit marker [21](#)

E

- e*Scope [16](#)
- Environment requirements [12](#)

- Ethernet port (rear panel) [19](#)
- Ethernet, connect to [36](#)
- expansion point, waveform [21](#)

F

- Fast Acq button [18](#)
- firmware, how to update [33](#)
- Force button [18](#)
- frequency domain display [23](#)
- front panel
 - Acquisition [18](#)
 - Autoset button [18](#)
 - Bus button (front panel) [18](#)
 - Channel buttons (front panel) [18](#)
 - Clear button [18](#)
 - Cursors button [18](#)
 - Default Setup [18](#)
 - description [18](#)
 - Fast Acq button [18](#)
 - Force button [18](#)
 - High Res button [18](#)
 - Horizontal [18](#)
 - input connectors [18](#)
 - Level knob [18](#)
 - Math button (front panel) [18](#)
 - Mode button [18](#)
 - multipurpose knobs [18](#)
 - position
 - knob (horizontal) [18](#)
 - Position knob [18](#)
 - probe compensation connectors [18](#)
 - Ref button (front panel) [18](#)
 - Run/Stop button [18](#)
 - Scale knob [18](#)
 - Scale knob (horizontal) [18](#)
 - Single/Seq button [18](#)
 - Slope button [18](#)
 - Touch Off button [18](#)
 - Trigger [18](#)
 - USB ports [18](#)
 - Vertical [18](#)

G

- GPIO talk/listen address [17](#)

H

- handle rotate [11](#)
- handles, analog and digital [21](#)
- HDMI output (rear panel) [19](#)
- High Res button [18](#)
- Horizontal controls [18](#)
- how to

how to *(continued)*

- check power-on self tests results [15](#)
- compensate TPP250, TPP0500B, TPP1000 probes [34](#)
- connect probes [15](#)
- connect to network [36](#)
- connect to PC using USB cable [17](#)
- download, install firmware [33](#)
- remote access the oscilloscope (from Web) [16](#)
- run signal path compensation (SPC) [34](#)
- set GPIB talk/listen address [17](#)
- set time [33](#)
- update firmware [33](#)
- use mouse with the UI [32](#)

I

- inactive channel buttons [21](#)
- Input connectors (front panel) [18](#)
- input signal level requirements [13](#)

K

- knob A [18](#)
- knob B [18](#)

L

- LAN port (rear panel) [19](#)
- LAN, connect to [36](#)
- Level knob [18](#)
- lock to bench or rack [14](#)
- LXI [16](#)

M

- manuals [10](#)
- Math button [18](#)
- Measure button [20](#)
- measurement badge [25](#)
- Menu bar [20](#)
- menu panels [29](#)
- menus [29](#)
- Mode button (front panel) [18](#)
- mouse touchscreen UI equivalents [32](#)
- multipurpose knobs [18](#)

N

- navigation buttons, badges [25](#)
- network, connect to [36](#)

O

- operating
 - altitude range [12](#)
 - humidity range [12](#)
 - temperature range [12](#)
- operating power requirements [12](#)

P

- panels, menu [29](#)
- pinching and handle rotate [11](#)
- position
 - knob [18](#)
 - knob (horizontal) [18](#)
- power cord connector (rear panel) [19](#)
- power requirements [12](#)
- power standby mode [14](#)
- power-on test results [15](#)
- powering on or off [14](#)
- probe
 - compensation (TPP0500B, TPP1000) [34](#)
 - compensation connectors [18](#)
 - compensation TPP250 [34](#)
 - inputs [18](#)
- probes, connecting [15](#)
- proper handle rotate [11](#)

R

- rack mount kit information [16](#)
- rear panel
 - AFG Out [19](#)
 - AUX Out [19](#)
 - cable lock [19](#)
 - connections [19](#)
 - Ethernet port (RJ-45) [19](#)
 - HDMI output [19](#)
 - LAN port (RJ-45) [19](#)
 - power cord [19](#)
 - security cable lock [19](#)
 - USB Device port [19](#)
 - USB Host ports [19](#)
- record view, waveform [21](#)
- Ref button [18](#)
- remote access (e*Scope) [16](#)
- remote access (Web-based) [16](#)
- remove AC power from instrument [14](#)
- requirements
 - altitude [12](#)
 - environment [12](#)
 - humidity [12](#)
 - power [12](#)
 - signal inputs [13](#)
 - temperature [12](#)
- Results bar [20](#)
- Results Table button [20](#)
- RF [23](#)
- RM3 rack mount [16](#)
- run signal path compensation [34](#)
- Run/Stop button [18](#)

S

- Save button [18](#)
- scale buttons, badge [25](#)
- Scale knob [18](#)

- Scale knob (horizontal) [18](#)
- search badge [25](#)
- Search button [20](#)
- security cable lock [19](#)
- set
 - GPIB talk/listen address [17](#)
 - time [33](#)
- Settings bar [20](#)
- signal input levels [13](#)
- Single/Seq button [18](#)
- Slope button (front panel) [18](#)
- SPC (signal path compensation) [34](#)
- standard accessories [11](#)

T

- TekVPI input connectors [18](#)
- time, how to set [33](#)
- Touch Off button [18](#)
- touchscreen UI tasks [32](#)
- trigger
 - level indicators [21](#)
 - position indicator [21](#)
- Trigger controls [18](#)
- turn instrument on or off [14](#)

U

- USB cable, connect to PC [17](#)
- USB Device port (rear panel) [19](#)
- USB Host ports (rear panel) [19](#)
- USB ports (front panel) [18](#)
- user documentation [10](#)
- using mouse with the touchscreen [32](#)

V

- Vertical controls [18](#)

W

- waveform
 - expansion point [21](#)
 - record view [21](#)
- waveform badge [25](#)
- Waveform View [20](#)

Z

- Zoom box [31](#)
- zoom icon [21](#)
- Zoom overview [31](#)
- Zoom title bar [31](#)